

Series 71, 72, and 76 Modutrol IV™ Motors

PRODUCT DATA

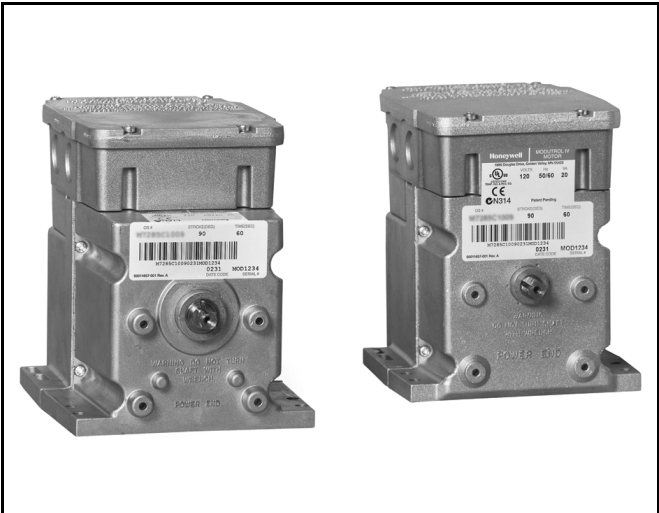

APPLICATION

The Series 71, 72 and 76 Modutrol IV Motors are spring return and non-spring return motors used to control dampers and valves. The motors accept a current or voltage signal from an electronic controller to position a damper or valve at any point between open and closed.

FEATURES

- Replaces M734H,J,; M744S,T,Y; and M745L,S,T,Y Motors.
- M7164, M7261, M7284, and M7294 are non-spring return motors; M7282, M7285, M7286 and M7685 are spring return motors.
- Integral spring return returns motor to normal position when power is interrupted.
- Integral junction box provides NEMA 3 weather protection.
- Motor and circuitry operate from 24 Vac. Models available with factory installed transformer, or a field added internal transformer.
- Quick-connect terminals are standard—screw terminal adapter is available.
- Adapter bracket for matching shaft height of older motors is available.
- Most motors have field adjustable stroke (90° to 160°).
- Die-cast aluminum housing.
- Integral auxiliary switches are available factory mounted, or can be field added.
- Nominal timing standard of 30 seconds (90° stroke), and 60 seconds (160° stroke). Other timings available.
- Spring return motors can operate valve linkages from power end or auxiliary end shafts for normally closed or normally open valve applications.
- All models have dual shafts (slotted and tapped on both ends).
- All models have auxiliary switch cams.
- Fixed torque throughout the entire voltage range.
- Motors are designed for either normally open or normally closed valves and dampers.
- Models available with adjustable start (zero) and span.
- Models available with 4 to 20 mA input signal.
- Models available with 2 to 10 Vdc input signal.

Contents

Application	1
Features	1
Specifications	2
Ordering Information	2
Installation	5
Settings and Adjustments	8
Operation and Checkout	11

SPECIFICATIONS

Models: TRADELINE models are selected and packaged to provide ease of stocking, ease of handling and maximum replacement value. TRADELINE model specifications are the same as those of standard models unless specified otherwise.

IMPORTANT

The specifications given in this publication do not include normal manufacturing tolerances. Therefore, an individual unit may not exactly match the listed specifications. Also, this product is tested and calibrated under closely controlled conditions and some minor differences in performance can be expected if those conditions are changed.

Modutrol IV Order Number Guide: See Table 4.

Dimensions: See Fig. 2.

Lifetime

60,000 Full Stroke Cycles
Repositions: 1.5 Million

Controller: These motors can be used with any electronic controller that provides a stable noise-free proportional current output as specified in Electrical Ratings, Input Range below.

Electrical Ratings:

Power Consumption: See Table 1.

Input Range:

Current, Nonadjustable: 4 to 20 mA nominal, 25 mA maximum.

Current, Adjustable: 4 to 20 mA adjustable, 50 mA maximum.

Zero/Null (Motor Closed): 0.0 to 18 mA.

Span: 1.8 to 20 mA.

Voltage, Nonadjustable: 2 to 10 Vdc.

Input Impedance:

4 to 20 mA Input: 100 ohms.

2 to 10 Vdc Input: 400K ohms.

Auxiliary Switch Ratings (in Amps): See Table 2.

Stroke: Most models available with field adjustable strokes from 90° to 160°. Stroke adjusted by means of potentiometers located in the wiring compartment.

Timing: Nominal 30 seconds for 90° stroke and 60 seconds for 160° stroke.

Dead Weight Load On Shaft: 200 lb (91 kg) on motor power or auxiliary end; maximum combined load of 300 lb (136 kg).

Ambient Temperature Ratings: -40 to 150°F (-40 to 66°C).

Shaft: 3/8 in. (9.5 mm) square.

Motor Rotation:

Closed: Counterclockwise rotation limit as viewed from motor power end.

Mechanically Normally Closed: Spring return. Normally closed motors rotate to closed position on power loss.

Electrically Normally Closed: Both spring return and non-spring motors return to closed position on minimum signal.

Table 1. Series 72 Modutrol IV Motor Power Consumption Ratings (at 120 Vac, 50/60 Hz).

Model	Power Consumption	
	VA	Watts
M7261	15	13
M7282	20	18
M7284	15	13
M7285	20	18
M7286	20	18
M7294	15	13

Table 2. Auxiliary Switch Ratings (in Amps).

One Contact Rating ^a	120V	240V
Full Load	7.2	3.6
Locked Rotor	43.2	21.6

^a 40 VA pilot duty, 120/240 Vac on opposite contact.

Approvals:

Underwriters Laboratories Inc. Listed: File No. E4436; Guide No. XAPX for USA and Canada.

U.S. Patents: pending

Table 3. Primary 50017460-001 Color Code

Lead Color	Primary Voltage
Brown	24 VAC
White	120 VAC
Blue	230 VAC
Black	Common

ORDERING INFORMATION

When purchasing replacement and modernization products from your TRADELINE® wholesaler or distributor, refer to the TRADELINE® Catalog or price sheets for complete ordering number. If you have additional questions, need further information, or would like to comment on our products or services, please write or phone:

1. Your local Honeywell Environmental and Combustion Controls Sales Office (check white pages of your phone directory).
2. Honeywell Customer Care
1885 Douglas Drive North
Minneapolis, Minnesota 55422-4386
3. <http://customer.honeywell.com> or <http://customer.honeywell.ca>

International Sales and Service Offices in all principal cities of the world. Manufacturing in Belgium, Canada, China, Czech Republic, Germany, Hungary, Italy, Mexico, Netherlands, United Kingdom, and United States.

Fig. 1. Stroke

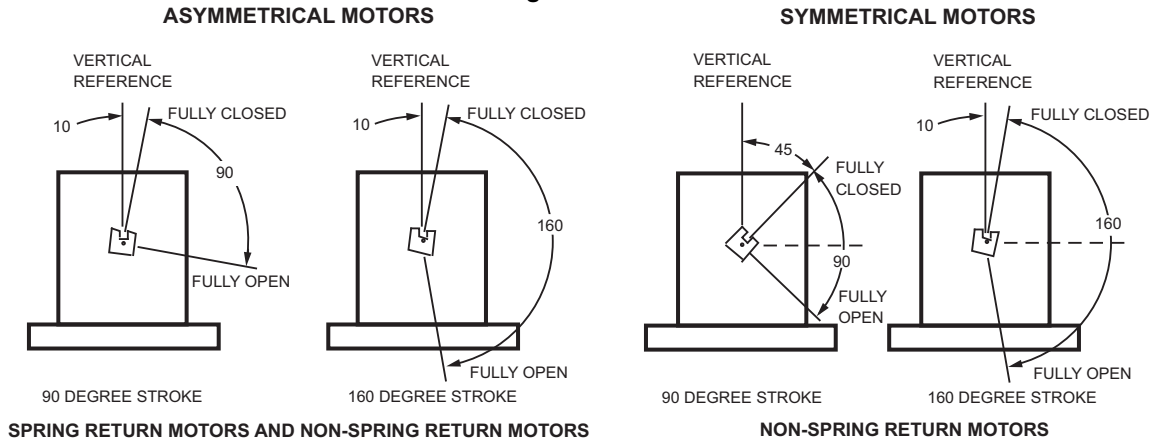

M31079

Table 4. Modutrol IV Motors Series 2 and 3 Model Number Guide.

M	Motor					
	71	10.5 - 13.5 Vdc voltage input				
	72	4-20 mA or 2-10 Vdc Control				
	76	14-17 dc voltage control with minimum position capability				
	6	—	35 lb-in. Non-Spring Return			
	7	—	75 lb-in. Non-Spring Return			
	8	60 lb-in. Spring Return	150 lb-in. Non-Spring Return			
	9	—	300 lb-in. Non-Spring Return			
	2	Dual-ended shaft		Normally Closed Spring Return		
	4			Non-Spring Return		
	5			Normally Closed Spring Return		
		A	0 Auxiliary Switches	Adjustable Stroke *	Normally Closed	
		B	1 Auxiliary Switch			
		C	2 Auxiliary Switches			
		D	0 Auxiliary Switch			
		Q^a	2 Auxiliary Switches			
M	72	8	4	A	XXXX	See Tradeline Catalog for Complete Model Number

^a Adjustable zero and span.

* Fixed stroke on M7284C1083, M7284C1091, M7284Q1082, and M7284Q1090

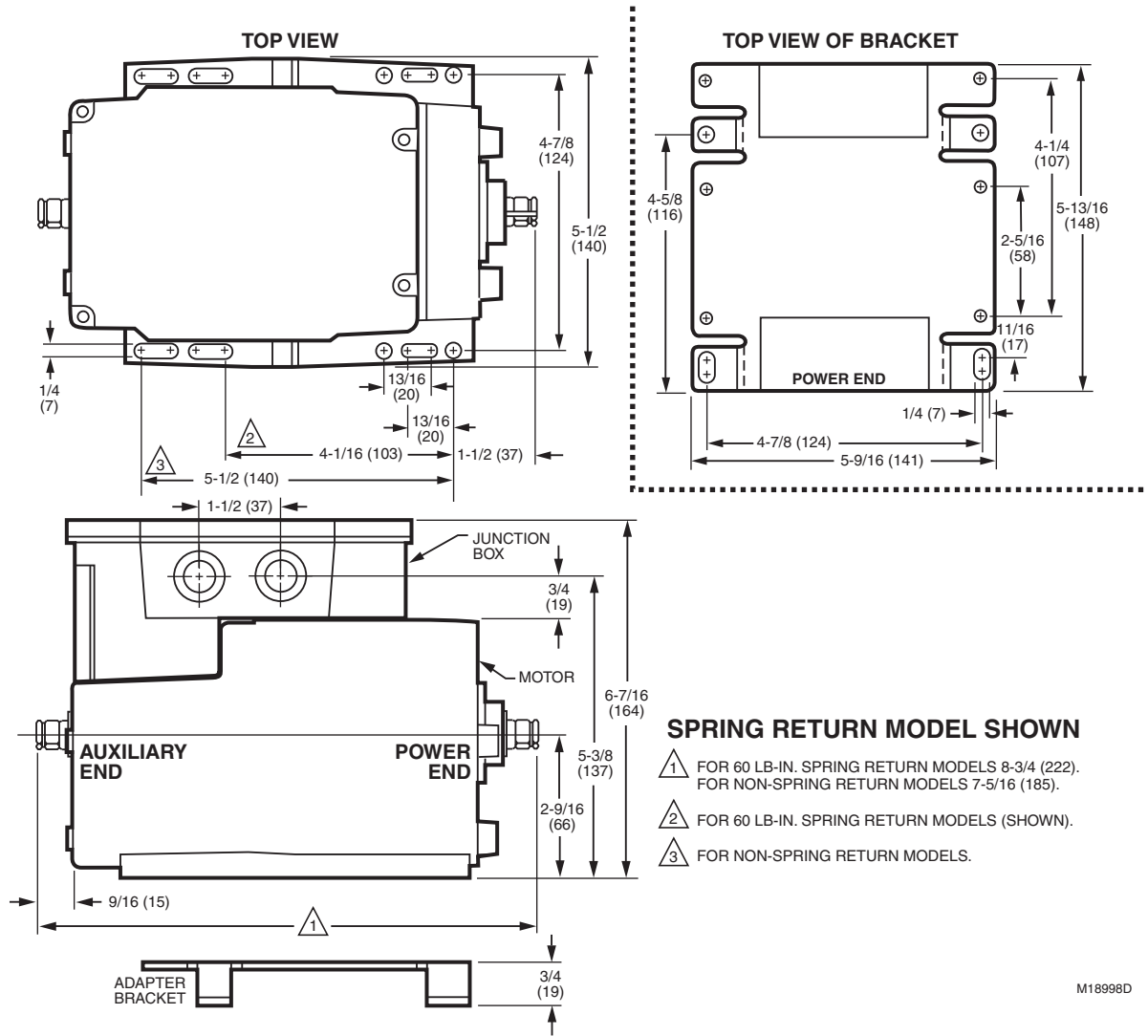

Fig. 2. Series 72 Modutrol IV Motor dimensions in inches (mm).

M18998D

Accessories:

- 220736A Internal Auxiliary Switch Kit; one switch.
Can be field-installed.
- 220736B Internal Auxiliary Switch Kit; two switches, can be field-installed on TRADELINE models.
- 220738A Adapter Bracket raises motor shaft height by 3/4 in (19 mm) to match that of previous Modutrol Motor models.
- 220741A Screw Terminal Adapter converts the standard quick-connect terminals to screw terminals.
- 221455A Infinitely Adjustable Crank Arm, can rotate through downward position and clear motor base without requiring an adapter bracket.
- 4074ERU Weatherproofing Kit provides NEMA 3 rating for Modutrol IV Motors mounted in position other than upright.
- 50017460-001 Internal Transformer; 24/120/230 Vac 50/60 Hz primary, 24 Vac secondary, quick connect terminals.
- 50017460-003 Internal Transformer; 120 Vac 50/60 Hz primary, 24 Vac secondary, quick connect terminals.
- 7617ADW Crank Arm, can rotate through downward position and clear motor base without requiring an adapter bracket.
- Q100 Linkage connects Modutrol Motor to V51 Butterfly Valve. Requires the 220738A Adapter Bracket.
- Q181 Auxiliary Potentiometer for sequence or unison control of 1 to 4 additional modulating (Series 90) motors.
- Q209E,F Manual Potentiometer for Modutrol Motors
- Q5001 Bracket and Linkage Assembly connects Modutrol IV Motor to water or steam valve.
- Q605 Damper Linkage connects motor to damper. Includes motor crank arm.
- Q607 External Auxiliary Switch controls auxiliary equipment as a function of motor position.
- ES650-117 Explosion-Proof Housing encloses motor for use in explosive atmospheres. Also required, a 7617DM coupling assembly from Honeywell to use with the cover. Not for use with Q5001 (or any other valve linkages). To order ES650-117, contact EGS Enclosures at (281) 449-6271, ask for the sales department and for distribution in your area.

INSTALLATION

When Installing this Product...

1. Read these instructions carefully. Failure to follow them could damage the product or cause a hazardous condition.
2. Check the ratings given in the instructions and on the product to make sure the product is suitable for your application.
3. Installer must be a trained, experienced service technician.
4. After installation is complete, check out product operation as provided in these instructions.



CAUTION

Electrical Shock or Equipment Damage Hazard.
Can shock individuals or short equipment circuitry.

Disconnect all power supplies before installation. Motors with auxiliary switches can have more than one disconnect.



CAUTION

Equipment Damage Hazard.
Can damage the motor beyond repair.

Never turn the motor shaft by hand or with a wrench. Forcibly turning the motor shaft damages the gear train and stroke limit contacts.

IMPORTANT

Always conduct a thorough checkout when installation is complete.

Location

Allow enough clearance for accessory installation and motor servicing when selecting a location (see Fig. 2). If located outdoors, use liquid-tight conduit connectors with the junction box to provide NEMA 3 weather protection. If mounted outdoors in a position other than upright, install a 4074ERU Weatherproofing Kit and liquid-tight connectors to provide NEMA 3 protection.



CAUTION

Motor Damage Hazard.
Deteriorating vapors and acid fumes can damage metal parts.

Install motor in areas free of acid fumes and other deteriorating vapors.

In excessive salt environments, mounting base and screws should be zinc or cadmium plated, not stainless steel or brass. Use the 220738A Adapter Bracket for mounting on these surfaces.

Mounting

Use the following guidelines for proper motor mounting:

- Always install motors with the crankshaft horizontal.
- Mounting flanges extending from motor housing base are drilled for 1/4 inch (6.4 mm) machine screws or bolts.
- Non-Spring Return Motors are shipped from the factory in the closed position (at the counterclockwise rotation limit, as viewed from the motor power end).
- Spring Return Motors are shipped from the factory in their normal position.
- Normally closed models are shipped at the counterclockwise rotation limit, as viewed from the motor power end.

Adapter Bracket

The 220738A Adapter Bracket, positioned between the motor and the equipment, raises motor shaft height by 0.75 in. (19 mm) to match that of previous Modutrol Motor models.

The following applications require this bracket:

- Q607 External Auxiliary Switch.
- Damper linkage applications requiring added clearance to allow:
 - Crank arm rotation through the downward position.
 - Sufficient damper linkage to reach the motor shaft.
- All valve linkages except the Q5001.

NOTE: When the bracket is not used in a replacement application, the damper linkage requires adjustment for the new shaft position.

To mount the motor with the bracket:

1. Mount the bracket to the equipment with existing or standard bolts.
2. Using the provided bolts, mount the motor to the bracket threaded holes. See Fig. 3.

For valve linkage applications (other than the Q5001):

1. Mount the bracket to the linkage.
2. Position the motor on the bracket to align the motor shaft with the linkage.

- Attach the motor to the bracket with the four bolts provided. See Fig. 4.

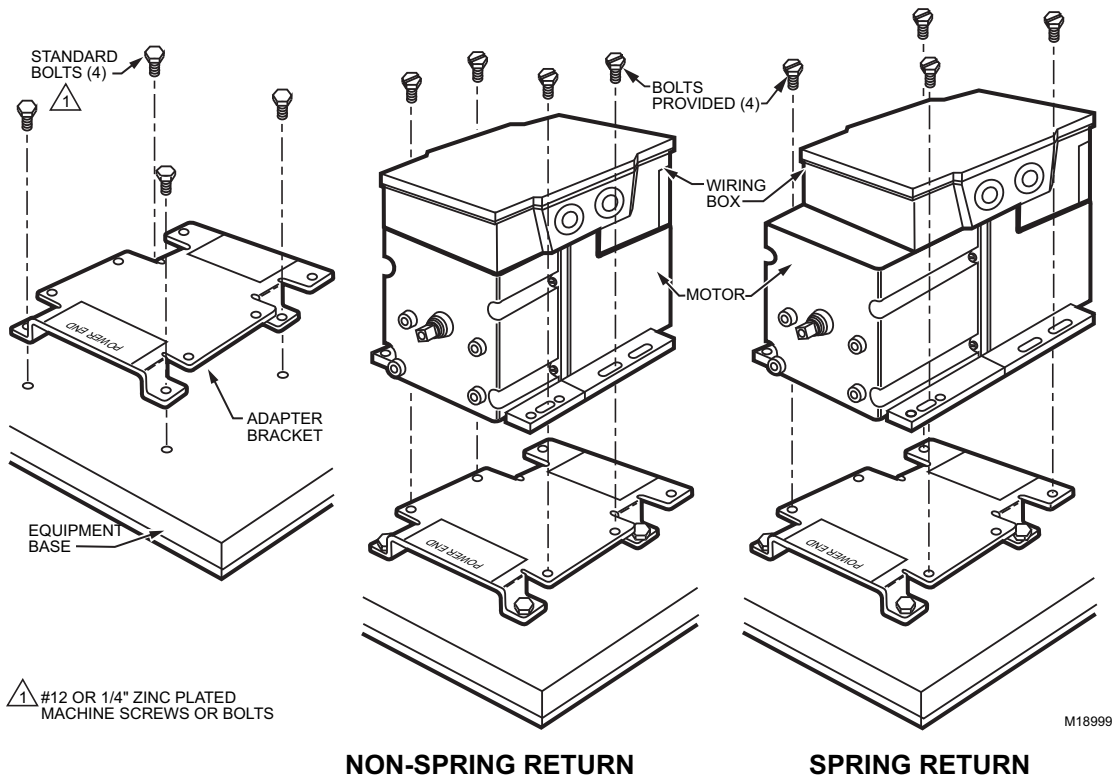

Fig. 3. Mounting the motor with an adapter bracket.

Damper Linkages

The motor does not include a crank arm. Order the crank arm separately (see Accessories in the Specifications section). For detailed instructions on the assembly of specific linkages, refer to the Installation Instructions packed with the linkage.



CAUTION

Equipment Damage Hazard.

Stalling a motor can damage the drive shaft.

Ensure installation of motors and linkages allows the motor to drive through full stroke without obstruction.

Valve Linkages

The Q100 Linkage requires a 220738A Adapter Bracket for all valve applications. Applications with the Q5001 Valve Linkage do not require the 220738A Adapter Bracket (see Fig. 4).

For detailed instructions on specific linkage assemblies, refer to the instruction sheet packed with the linkage. In general, check the following points when installing a motor and linkage:

- Adjust valve and louver-type damper linkages so the damper or valve moves through only the maximum required distance while the motor moves through its full stroke.
- With modulating control, maximum damper opening should be no more than 60 degrees. Little additional airflow is provided beyond this point.
- Do not exceed load and torque ratings in any application.

Junction Box

When used with liquid-tight conduit connectors, the junction box provides NEMA 3 weather protection for the motor. The junction box, standard with replacement motors, encloses the terminals and provides knockouts for wiring conduits. Housing an internal transformer or internal auxiliary switches requires using a junction box.

3. Replace wiring box cover.

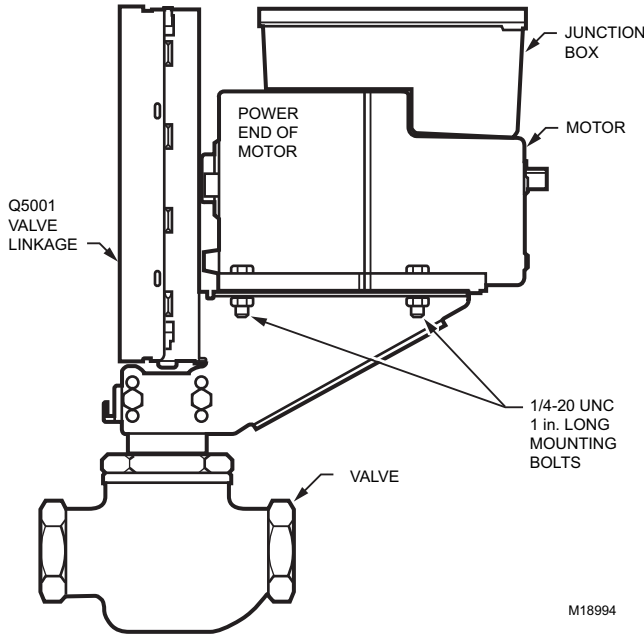

Fig. 4. Mounting the motor on a Q5001 Valve Linkage.

Wiring



CAUTION

Electrical Shock or Equipment Damage Hazard.
 Can shock individuals or short equipment circuitry.
 Disconnect all power supplies before installation.
 Motors with auxiliary switches can have more than one disconnect.

IMPORTANT

All wiring must agree with applicable codes, ordinances and regulations.

1. Ensure that the voltage and frequency stamped on the motor correspond with the power supply characteristics.
2. When connecting several motors in parallel, ensure that the power supply VA rating is large enough to provide power to all motors used without overloading.
3. Fig. 10 shows that motor terminals are quick-connects located on top of the printed circuit board.
4. To access the wiring compartment:
 - a. Remove the four screws from the junction box top.
 - b. Lift off the cover.
5. Refer to Fig. 5 through 8 for wiring.

Wire the motor as follows:

1. Remove the wiring box cover by removing the four screws holding the cover to the motor.
2. Wire motor to system using quick-connect terminals in wiring box.

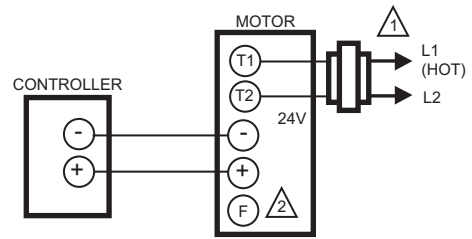

1 POWER SUPPLY. PROVIDE DISCONNECT MEANS AND OVERLOAD PROTECTION AS REQUIRED.

2 CONNECTING F TO - WILL DRIVE MOTOR TO FULLY OPEN.

M5778

Fig. 5. Typical system wiring.

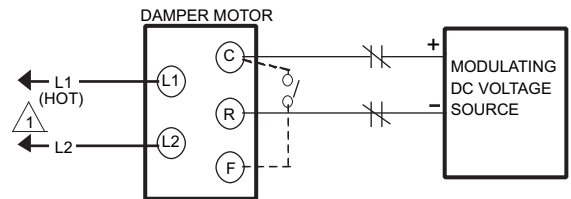

1 POWER SUPPLY. PROVIDE DISCONNECT MEANS AND OVERLOAD PROTECTION AS REQUIRED.

M13726

Fig. 6. Series 71 optional override switches to drive motor open or closed.

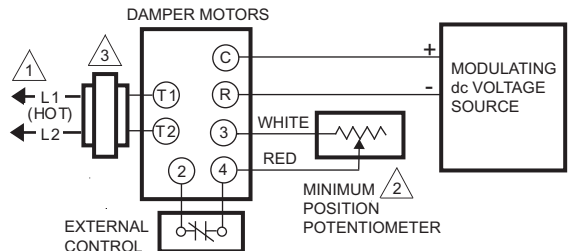

1 POWER SUPPLY. PROVIDE DISCONNECT MEANS AND OVERLOAD PROTECTION AS REQUIRED.

2 IF MINIMUM POSITION POTENTIOMETER IS NOT USED, JUMPER TERMINALS 3 AND 4.

3 TRANSFORMER MAY BE INTERNAL OR EXTERNAL.

M13727A

Fig. 7. M7685 Typical application wiring.

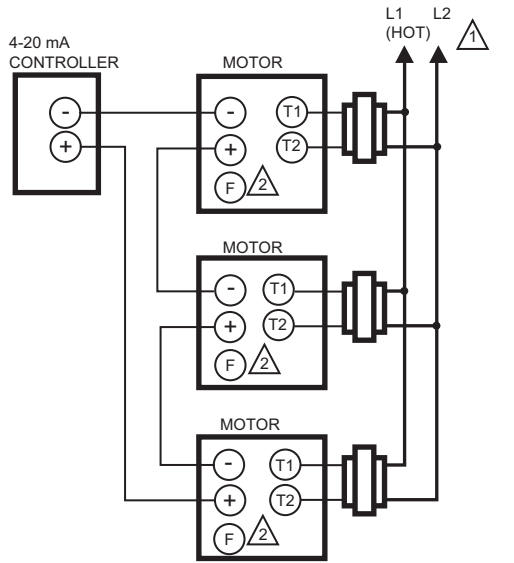

- ⚠ POWER SUPPLY. PROVIDE DISCONNECT MEANS AND OVERLOAD PROTECTION AS REQUIRED.
- ⚠ CONNECTING F TO - WILL DRIVE MOTOR TO FULLY OPEN. MOTORS FUNCTION INDEPENDENTLY.

M31109

Fig. 8. Driving up to six motors from one 4 to 20 mA controller.

SETTINGS AND ADJUSTMENTS

Before Setting Stroke

1. Remove the top cover from the motor.
2. Disconnect the controller from the motor.
3. For models with an internal transformer (line voltage motors), ensure that power (and nothing else) remains connected to the motor.

IMPORTANT

Detach linkage from motor before adjusting stroke.



CAUTION

Careless Installation Hazard.

Use of excessive force while adjusting cams damages the motor.

To avoid damaging motor end switches, set cams by moving only the screwdriver top.



CAUTION



Equipment Damage Hazard.

Can damage the motor beyond repair.

Never turn the motor shaft by hand or with a wrench. Forcibly turning the motor shaft damages the gear train and stroke limit contacts.

Adjustable Stroke

All models except for M7284C1083, M7284C1091, M7284Q1082, and M7284Q1090.

When viewing from the power end of the motor, the stroke potentiometer is to the far left. To set the stroke to 160° (maximum position) turn the potentiometer fully clockwise , using a 1/8 in. straight-blade screwdriver. To set the stroke at 90° (minimum position) turn the potentiometer fully counter-clockwise . Setting the potentiometer anywhere between fully clockwise and fully counter-clockwise will set the stroke between 160° and 90°.

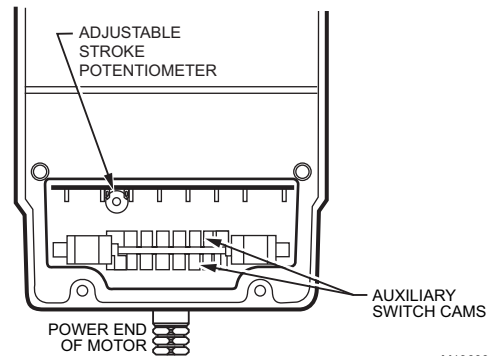

M13699

Fig. 9. Stroke adjustment setup

Zero and Span Adjustment for M7284Q, M7285Q, and M7294Q

M7284Q, M7285Q, and M7294Q actuators have the capability of adjustable zero and span. Fig. 10 shows the module with the zero and span potentiometers.

Zero: Sets input voltage to define the 0% angle of rotation. It is factory set to minimum position and can be adjusted to the maximum position of 20mA or 10V.

Span: Adjusts motor response to travel a full stroke through the selected input span. It is factory set to maximum position, and is adjustable from 4-20mA or 2-10Vdc.

1. Adjust the start potentiometer fully clockwise (maximum zero) and the span potentiometer fully counterclockwise (minimum span). See Fig. 10.
2. Set the controller current to the value required to drive the motor to the closed position.

3. Turn the start potentiometer slowly counterclockwise until the motor begins to open. This is defined as the start or zero setting.
4. Set the controller current to the value required to drive the motor to the fully open position. The motor will open.
5. Turn the span potentiometer clockwise until the motor starts to close. The difference between the fully open span position current and the zero position current is defined as the operating span.
6. Recheck the start and readjust the span potentiometer if necessary. Turn the start potentiometer clockwise to increase the zero position.
7. Recheck the span and readjust the span potentiometer if necessary. Turn it clockwise to increase the full span position.
8. For sequential operation, as shown in Fig. 11, repeat the above steps for each motor.

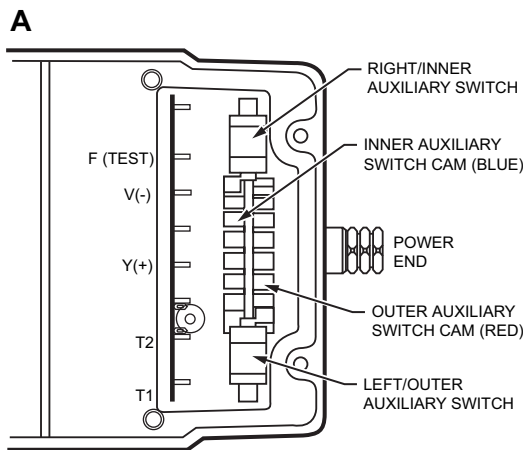

NOTE: FEATURES AVAILABLE ON SOME MODELS ONLY.
2 TO 10 VDC INPUT MOTORS

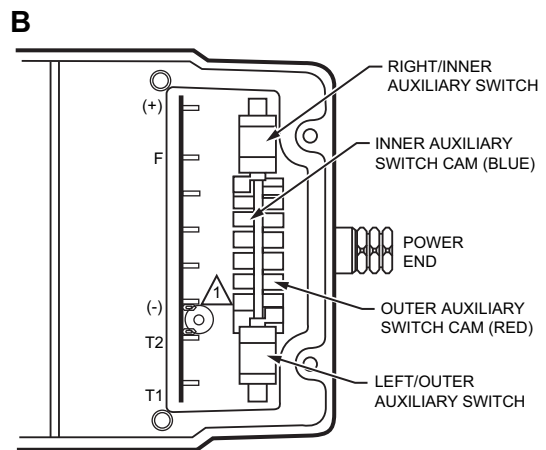

NOTE: FEATURES AVAILABLE ON SOME MODELS ONLY.
4 TO 20 mA NONADJUSTABLE INPUT MOTORS

△ RESOLUTION POTENTIOMETER, 160 ON M7284C1083, M7284C1091, M7284Q1082, AND M7284Q1090

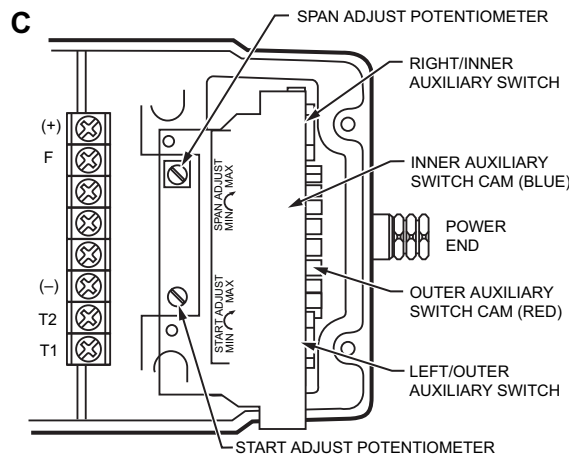

NOTE: FEATURES AVAILABLE ON SOME MODELS ONLY.
4 TO 20 mA ADJUSTABLE INPUT MOTORS

M13648A

Fig. 10. Terminals and adjustments.

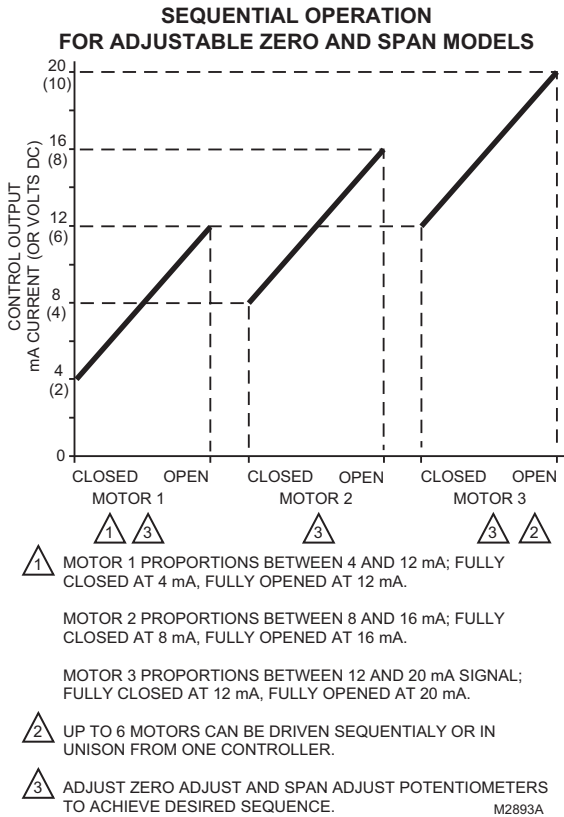

Fig. 11. Sequential operation of motors.

Enhanced Resolution M7284C1083, M7284C1091, M7284Q1082, and M7284Q1090

These four motors have enhanced resolution with 160 repositions (steps) from 90 degrees to 160 degrees stroke.

Auxiliary Switches

CAUTION
Electrical Shock or Equipment Damage Hazard.
Can shock individuals or short equipment circuitry.
Disconnect all power supplies before installation. Motors with auxiliary switches can have more than one disconnect.

CAUTION
Equipment Damage Hazard.
Can damage the motor beyond repair.
Never turn the motor shaft by hand or with a wrench. Forcibly turning the motor shaft damages the gear train and stroke limit contacts.

Adjustable cams actuate the auxiliary switches. These cams can be set to actuate the switches at any angle within the motor stroke. Select switch differential of 1° or 10°.

Motors with factory added auxiliary switches are shipped in the closed position (fully counterclockwise, as viewed from the motor power end) with auxiliary cams set to actuate switches 30° from the closed position and to provide 1° degree differential. With the motor in the closed (fully counterclockwise) position, the auxiliary switch breaks contacts R-B. See Fig. 12 for auxiliary switch wiring.

Series 2 Motors are shipped with auxiliary switch cams that permit acceptance of 220736A,B Internal Auxiliary Switch Kits. Refer to form 63-2228 for 220736A,B Installation Instructions.

Auxiliary Switch Adjustment

IMPORTANT

When adjusting the auxiliary switch cams use the following procedure:

1. Insert 1/8 in. screwdriver blade into a slot on cam and move the screwdriver top as far as possible in the required direction. See Fig. 12.
2. Repeat step 1 in successive cam slots until the cam is in the required position.

NOTE: Series 2 Motors are shipped with auxiliary switch cams that permit acceptance of 220736A,B Internal Auxiliary Switch Kits. Refer to Form no. 63-2228 for 220736A,B Installation Instructions.

Use the following procedure to obtain the desired auxiliary switch settings:

1. Remove the top cover from the motor to gain access to the motor terminals and auxiliary cams.
2. Disconnect the controller from the motor.
3. Connect a current source to the positive and negative terminals.
4. Drive the motor to the position where the auxiliary equipment is to be switched by increasing or decreasing the current.
5. For a switch differential of 1°, check continuity of auxiliary switch contacts R-B and rotate the cam as follows:
 - a. If the contacts are open, rotate the cam clockwise until the R-B contacts close.
 - b. If the contacts are closed, rotate the cam counterclockwise until the R-B contacts open.
6. For a switch differential of 10° rotate the cam approximately 180° so the slow-rise portion of the cam actuates the switch.
7. Check continuity of the auxiliary switch contacts R-B.
8. Rotate the cam as follows:
 - a. If the contacts are open, rotate the cam counterclockwise until the R-B contacts close.
 - b. If the contacts are closed, rotate the cam clockwise until the R-B contacts open.
 - c. Make final adjustment in the proper direction to obtain contact make or break at the desired position.
9. Check for the proper differential and switching of the auxiliary equipment by driving the motor through the full stroke in both directions.
10. Disconnect power, remove current source, reconnect the controller, and replace the top cover on the motor.

NOTE: Changing the differential from 1° to 10° reverses the switching action. For example, with a 10° differential, switch contacts R-B make and R-W break on a counterclockwise (closed) rotation. With a 1° differential, switch contacts R-W make and R-B break on a counterclockwise (closed) rotation.

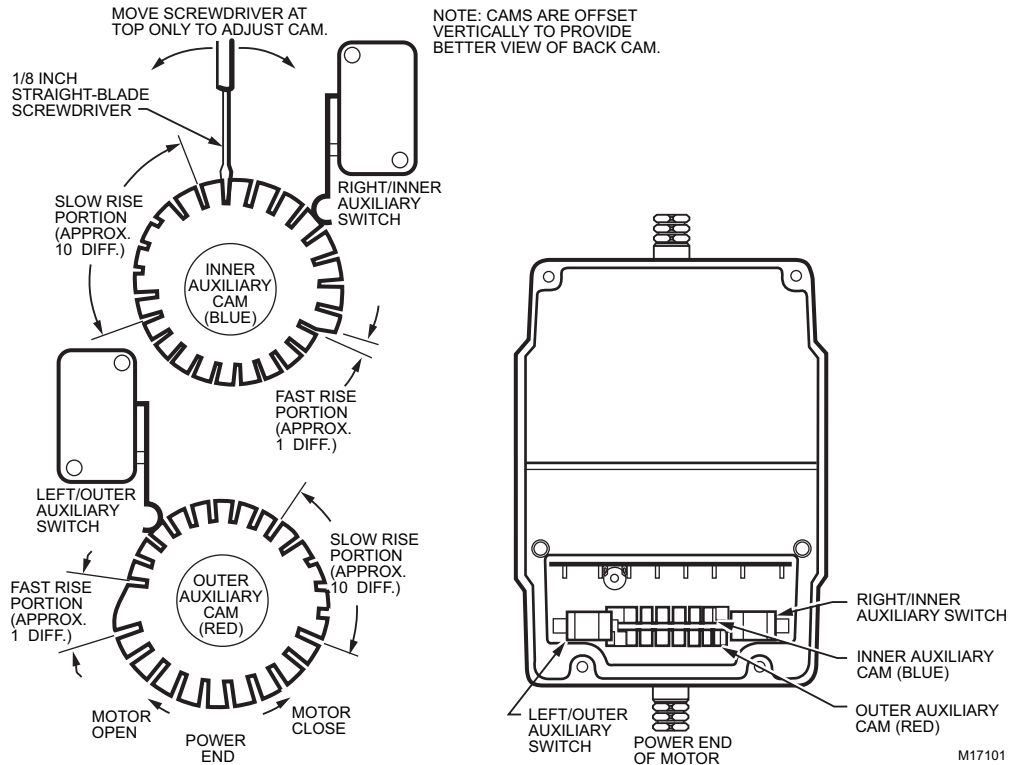

Fig. 12. Auxiliary switch adjustment.

OPERATION AND CHECKOUT

Operation

The internal shaft position feedback potentiometer in conjunction with the actuator microprocessor and modulating input circuit form a control loop. When the external controller's output remains at a fixed amplitude the actuator's shaft position is held at a position proportional to that input amplitude. When the value of the external controller's output changes the actuator responds by initiating movement of the motor to proportionately compensate for the change in input amplitude. When the motor reaches the control loop balance point the system is again in a static state and the actuator holds position until the next change of input from the external controller.

M7685 motor also have a minimum position feature. An external 130 ohm potentiometer wired to terminals 3 and 4 establishes a position beyond which the control input cannot close the motor. If power to the T1-T2 is interrupted the M7685 motor will spring close.

Checkout

After installation and linkage adjustment, operate the motor through the controller. Make sure that:

- The motor properly operates the damper or valve.
- The motor responds properly as the input is varied.
- The auxiliary switch, if used, operates at the desired point of motor rotation.

Inspect the motor, linkage, and valve or damper to see that all mechanical connections are correct and secure.

In damper installations, the pushrod should not extend more than a few inches past the ball joints. Check to see that there is adequate clearance for the linkage to move through its stroke without binding or striking other objects.

See controller or system instructions for additional checkout procedures.

Motor Operation Checkout

For motors with F, + and - terminals:

To close the motor, open terminals +, -, and F.

To open the motor connect terminal F to positive (+) or negative (-).

NOTE: DO NOT SHORT + to -

M7164A1017 and M7164G1030 do not have + or - terminals, and operate as follows:

The motor closes if it does not receive an input to F.

To open the motor, short F to C.

M7685A1025 is a normally open motor, and operates as follows:

To close the motor, short 3 to 4 or short 3 to C.

The motor opens if it does not have an input to 3.